

# ACP- GREASE INTERCEPTOR-MODEL GTI-4500

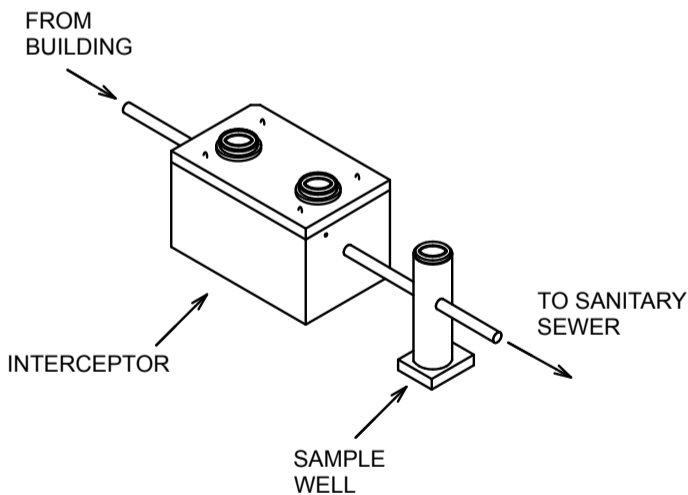
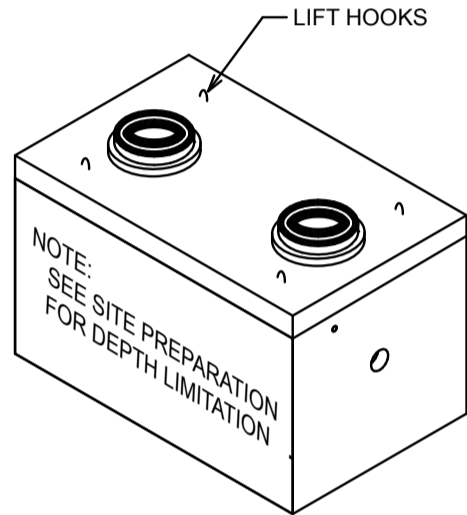
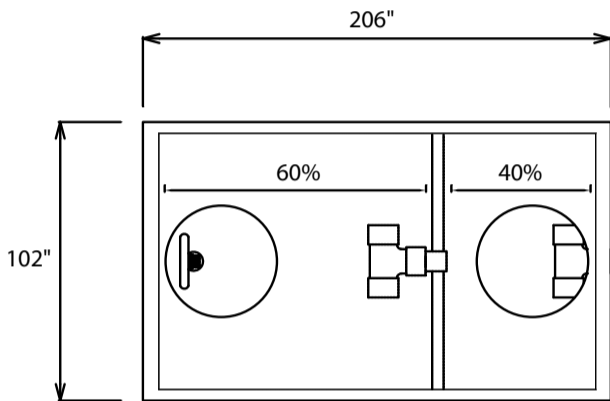
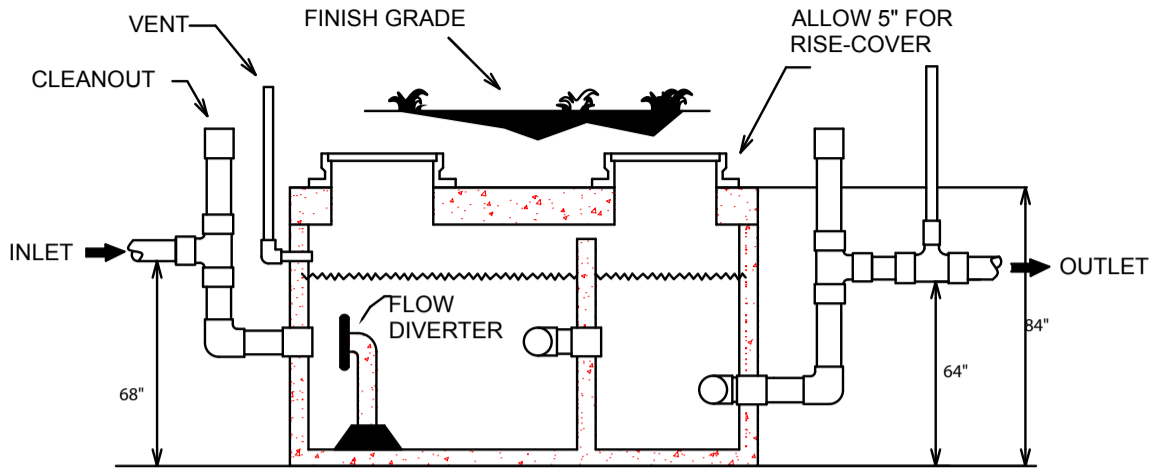

GREASE INTERCEPTOR DIMENSIONS						
MODEL NO. GTI	LENGTH	WIDTH	HEIGHT	INLET	OUTLET	WEIGHT
500 GAL.	76"	56"	60"	48"	44"	9,000 LBS
750 GAL.	104"	56"	60"	48"	44"	12,000 LBS
1000 GAL.	112"	68"	60"	48"	44"	16,400 LBS
1250 GAL.	136"	68"	60"	48"	44"	17,500 LBS
1500 GAL.	140"	80"	60"	48"	44"	20,300 LBS
2000 GAL.	150"	102"	60"	48"	44"	26,000 LBS
2500 GAL.	132"	92"	84"	68"	64"	26,200 LBS
3000 GAL.	156"	92"	84"	68"	64"	29,600 LBS
3500 GAL.	174"	92"	84"	68"	64"	32,300 LBS
4000 GAL.	182"	102"	84"	68"	64"	41,200 LBS
4500 GAL.	206"	102"	84"	68"	64"	45,500 LBS
5000 GAL.	164"	102"	108"	93"	89"	46,000 LBS
5500 GAL.	182"	102"	108"	93"	89"	48,000 LBS
6000 GAL.	194"	102"	108"	93"	89"	50,300 LBS

LARGER TANKS AVAILABLE UP TO 20,000 GAL.

ACP-2011



**AFFORDABLE  
CONCRETE  
PRODUCTS INC.**

SPECS FOR:

CITY OF AUSTIN

SCALE:  
NONE

MODEL:  
GTI-4500

**STANDARD SPECIFICATIONS** ACP-2011

- \*4500 PSI CONCRETE CLASS 1
- \*GRADE 60 REINFORCING STEEL
- \*8" TRAFFIC LID/H-20 RATED
- \*ALLOW 5" RING AND COVER IN TOTAL HEIGHT
- \*INLET/OUTLET / 4" SCH40 PVC (6" AVAILABLE)
- \*MAXIMUM DEPTH TO BOTTOM OF TANK: 10FT

**MAIL:**  
P.O. BOX 1377  
BUDA TEXAS 78610  
512-312-2121  
FAX: 512-295-5534

**SHIP:**  
600 SOUTH LOOP 4  
BUDA TEXAS 78610  
512-312-2121  
FAX: 512-295-5534

EMAIL: [ACP500@aol.com](mailto:ACP500@aol.com)  
WEBSITE:  
[www.affordableconcreteproducts.com](http://www.affordableconcreteproducts.com)

**ENGINEERING DATA**

- \*INTERCEPTOR IS HYDRAULICALLY & STRUCTURALLY ENGINEERED TO CONFORM WITH LOCAL UNIFORM PLUMBING CODE.
- \*INTERCEPTOR WILL BE FACTORY ASSEMBLED PRIOR TO DELIVERY.
- \*USE DIMENSIONAL DATA AS SHOWN FOR FIELD EXCAVATION.
- \*(MUST BE COMPLETE PRIOR TO DELIVERY)